

Belmont™

18

YOUR OBJECTIVE:

To learn the correct method for installing Belmont™.

BELMONT

This shingle is a “better” quality roofing product. This means that when offering a choice of “good,” “better” and “best” products, this shingle would fall in the “better” category. Belmont is an oversized 18" x 36" designer shingle with an 8" exposure.

Fastening, steep slopes, and flashing requirements are special because of the thickness, design, and weight of this product.

FOR UL FIRE RATING, underlayment may be required. Apply flat and unwrinkled.

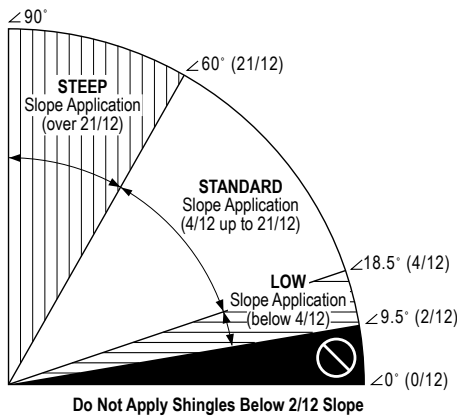

Figure 18-1: Slope definitions.

STANDARD OR STEEP SLOPES: CertainTeed recommends DiamondDeck®, Synthetic Underlayment, RoofRunner™, Roofers’ Select® High Performance Underlayment, or shingle underlayment meeting ASTM D226, D4869 or D6757. Take care to ensure sufficient deck ventilation when DiamondDeck, RoofRunner or other synthetic underlayment is installed. Follow manufacturer’s application instructions.

LOW SLOPES: All roof shingles applied to a low slope deck (2" to below 4" per foot) require the use of CertainTeed WinterGuard® Waterproofing Shingle Underlayment, or its equivalent,* applied over the entire deck surface. Consult the WinterGuard and individual shingle application instructions for details.

- * For low slopes, underlayment equivalents to WinterGuard include:
- 1) waterproofing shingle underlayments meeting ASTM D1970;
 - 2) in areas not prone to snow or ice, two layers of 36" (915 mm) wide felt shingle underlayment lapped 19" (485 mm).
 - 3) in areas not prone to snow or ice, two layers of CertainTeed’s DiamondDeck or RoofRunner™ in shingle fashion (half lap) per the low-slope application instructions.

Shingle underlayment should meet ASTM D6757, ASTM D4869 Type I or ASTM D226 Type I. Ensure sufficient deck ventilation when DiamondDeck, RoofRunner or other synthetic underlayment is installed.

THE ROOF DECK MUST BE AT LEAST: 3/8" (9.5 mm) thick plywood, or 7/16" (11 mm) thick non-veneer, or 1" (25 mm) thick nominal wood deck.

COLD WEATHER CLIMATES (ALL SLOPES): Application of WinterGuard or a waterproofing shingle underlayment meeting ASTM D1970 is strongly recommended whenever there is a possibility of ice build-up. Follow manufacturer’s application instructions.

FLASHING: Corrosion-resistant flashing must be used to help prevent leaks where a roof meets a wall, another roof, a chimney or other objects that penetrate a roof.

SEALING: Shingle sealing may be delayed if shingles are applied in cool weather and may be further delayed by airborne dust accumulation. If any shingles have not sealed after a reasonable time period, hand sealing may be necessary.

CAUTION: To prevent cracking, shingles must be sufficiently warm to allow proper forming for hips, ridges and valleys.

WARRANTY: These shingles are warranted against manufacturing defects and are covered by SureStart™ protection. See the warranty itself for specific details and limitations.

For technical questions, information on acceptable alternative application methods and materials, or a copy of the product warranty, contact the sources listed below:	Warranty	Alternate Instructions	Technical Questions
	Your supplier or roofing applicator	✓	
	CertainTeed Home Institute 800-782-8777	✓	✓
	CertainTeed-RPG Technical Services 800-345-1145	✓	✓

FASTENING

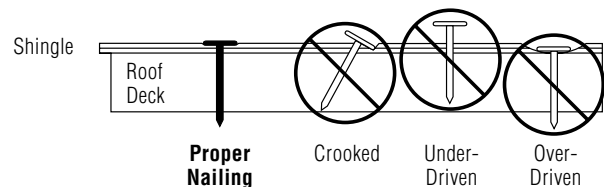

Figure 18-2: Proper and improper nailing.

IMPORTANT: For decks 3/4" (19 mm) thick or thicker, nails must go at least 3/4" (19 mm) into the deck. On thinner decks, nails must go at least 1/8" (3.2 mm) through the deck.

Nails must be 11 or 12 gauge roofing nails, corrosion-resistant, with at least 3/8" (9.5 mm) heads, and at least 1 1/4" (32 mm) long.

NOTE: Nails are **required** as fasteners for this product; staples are not allowed.

LOW AND STANDARD SLOPE

Use FIVE nails for every full shingle located as shown below.

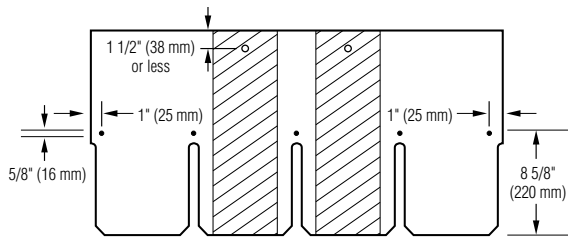

Figure 18-3: Use five nails for every full shingle.

STEEP SLOPE

Use SEVEN nails and EIGHT spots of asphalt roofing cement for every full shingle as shown below. Apply asphalt roofing cement 1" (25 mm) from edge of shingle. Asphalt roofing cement meeting ASTM D 4586 Type II is suggested.

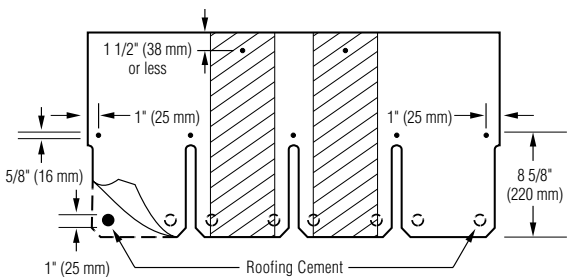

Figure 18-4: Use seven nails and eight spots of asphalt roofing cement on steep slopes.

IMPORTANT: To prevent slippage of the laminated tabs (shown cross-hatched above) when individual shingles meet a wall, ridge, and on steep slopes (greater than 21" per foot), each laminated tab at the junction must be fastened individually with an additional fastener as shown. Fasteners applied to the tabs in this manner are to be horizontally centered on the laminated tab and placed within 1 1/2" (38 mm) of the upper edge of the shingle. To protect against slippage of the laminated tabs during application of these shingles in hot weather, it might become necessary to fasten all the tabs individually as described above.

CAUTION: Excessive use of roofing cement can cause shingles to blister.

SINGLE-COLUMN VERTICAL RACKING METHOD

FOUR-AND-ONE-HALF-INCH OFFSET, SINGLE-COLUMN, VERTICAL RACKING METHOD ("RACKING")

UNDERLAYMENT: Apply as required, following manufacturer's instructions. Figure 4 illustrates application of Roofers' Select® and standard felt underlayment, for standard or steep-slopes only. Always ensure sufficient deck ventilation, and take particular care when DiamondDeck® or other synthetic underlayment is installed. Follow manufacturer's application instructions.

ALIGNMENT: Snap horizontal and vertical chalklines to assure shingles will be correctly aligned. Expose all shingles to 8" (203 mm).

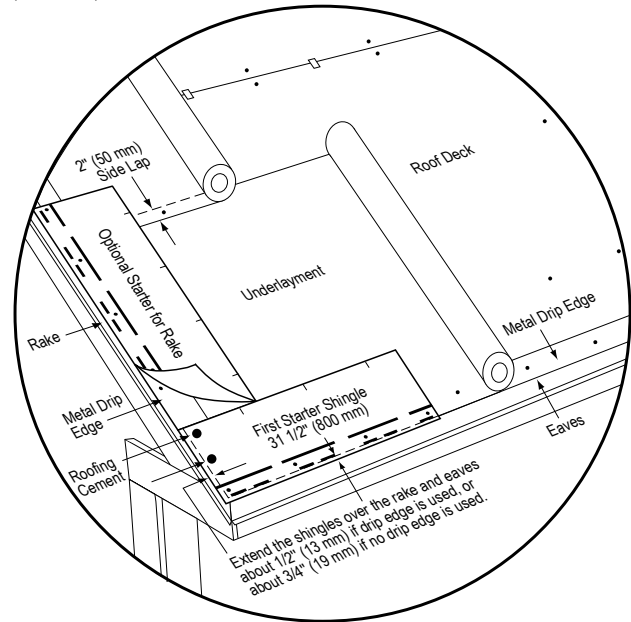

Figure 18-5: Standard slope underlayment and starter drip edge details.

STARTER COURSE (IMPORTANT): Use CertainTeed's High-Performance Starter Shingles or remove the lower 8" (203 mm) tab portions from Belmont shingles. **DO NOT ROTATE OR "FLIP" FULL SHINGLE. SEALANT STRIPES MUST BE AT LOWER-MOST EDGE.**

Cut 4 1/2" (115 mm) off the **LEFT** end of the first starter shingle only. Apply the 31 1/2" (800 mm) remaining piece to the lower left corner of the roof. Install nails approximately 3" (76 mm) up from eave, assuring they go into solid wood. Use full length High-Performance Starter or cut Belmont™ shingles as a starter for the rest of the course. For added protection, it is suggested, not required, to install Belmont starter shingles or CertainTeed's High-Performance Starter [10" x 36" (254 mm x 914 mm)] along the rake edges of the roof and butt shingles (DO NOT OVERLAP).

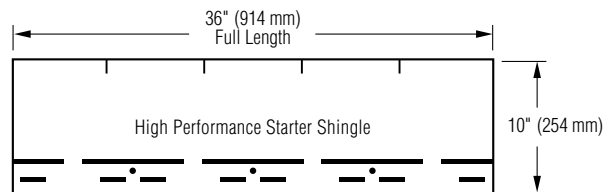

Figure 18-6: High-performance starter shingle.

1ST COURSE: Apply a full Belmont shingle at the lower left corner of the roof, flush with the starter course left corner. Fasten with 5 nails (See Figure 18-7).

2ND COURSE: Cut $4\frac{1}{2}$ " (115 mm) off the left end of a full shingle and apply remaining $31\frac{1}{2}$ " (800 mm) piece over left edge of 1st course. Fasten with 5 nails and ensure 8" (203 mm) exposure (See Figure 18-7).

SUCCEEDING COURSES: Begin application of the 3rd course with a full shingle. Fasten with 4 nails, leaving the right end unfastened until later (See Figure 18-7).

Begin the 4th course using a shingle with $4\frac{1}{2}$ " (115 mm) cut off its left end. Fasten with 5 nails. To begin the application of subsequent courses, alternate full shingles [36" (914 mm)] and cut shingles [$31\frac{1}{2}$ " (800 mm)] up the rake edge, fastening as described.

REMAINING COLUMNS AND COURSE COMPLETION: Apply a full shingle against the right edge of each shingle in previous column.

When applying a shingle against a covered shingle, carefully lift the right edge of the shingle above and slip the new shingle under it. Fasten as usual with 5 fasteners; then, fasten the loose right edge of the shingle above (See Figure 18-8).

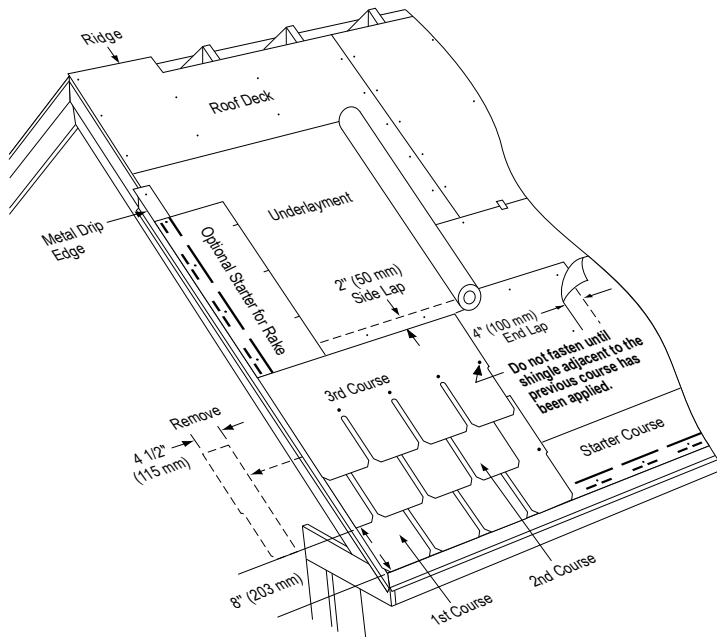

Figure 18-7: Applying the first 3 courses on a standard slope.

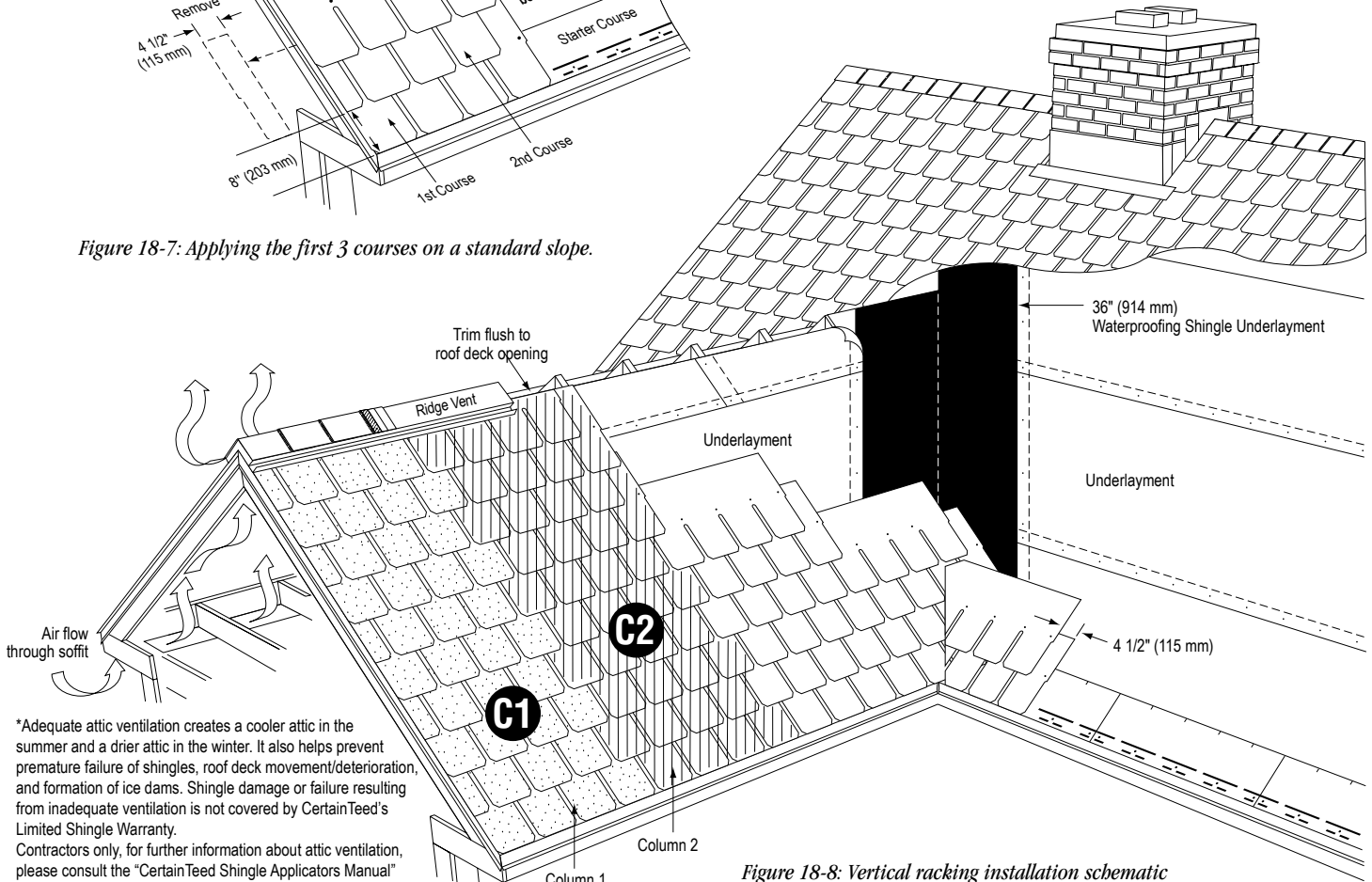

Figure 18-8: Vertical racking installation schematic

*Adequate attic ventilation creates a cooler attic in the summer and a drier attic in the winter. It also helps prevent premature failure of shingles, roof deck movement/deterioration, and formation of ice dams. Shingle damage or failure resulting from inadequate ventilation is not covered by CertainTeed's Limited Shingle Warranty. Contractors only, for further information about attic ventilation, please consult the "CertainTeed Shingle Applicators Manual" (call 1-800-404-9880 for a copy), and/or "The Principles of Attic Ventilation" brochure (call 1-800-AIRVENT for a copy).

INSTALLING VALLEYS

- ◆ Closed-cut and open valleys are recommended.
- ◆ When installing an open valley, preformed "W" style valleys are preferred.

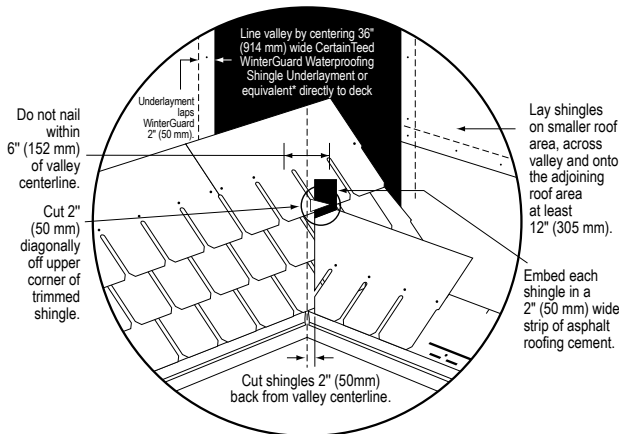

Figure 18-9: Closed-cut valley installation.

CHIMNEY FLASHING

METAL STEP FLASHING: First course of metal flashing must consist of a minimum 5" x 12" (127 mm x 305 mm) piece applied flush with the lowermost edge of the first shingle. Succeeding courses of flashing must consist of pieces that are a minimum 5" x 10" (127 mm x 254 mm) in size. Each succeeding course of flashing must "overlap" the flashing course beneath it a minimum of 2" (50 mm).

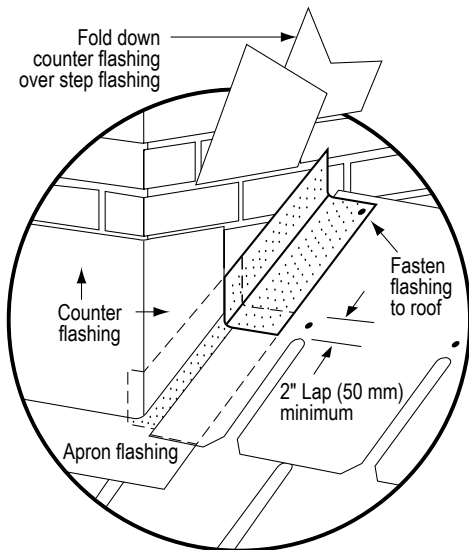
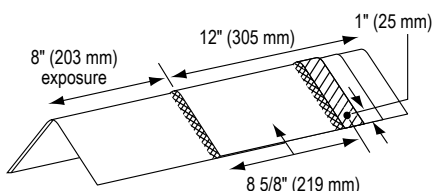

Figure 18-10: Flashing around a chimney.

CEDAR CREST® HIP AND RIDGE



Use Cedar Crest accessory shingles of a like color to cover hips and ridges. Carefully separate the three-piece units prior to application, by first folding along the pre-cut lines and then detaching the pieces (see Figure 18-11). No cutting is necessary. There are 30 individual shingles (10 three-piece units) in each bundle. One bundle will cover 20 linear feet. Each 12" x 12" (305 mm x 305 mm) shingle has a shadowline that is a design feature which is visible when applied properly. To prevent shingle damage during application, they must be sufficiently warm to allow proper forming.

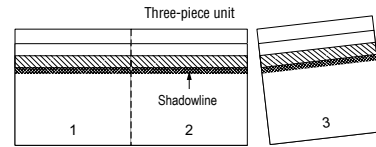

Figure 18-11: Separate to make 3 cap shingles.

FASTENING

IMPORTANT: Use TWO nails to fasten each shingle. Fasteners must be minimum 1³/₄" (45 mm) long. For the starter shingle, place fastener 1" (25 mm) in from each side edge and about 2" (50 mm) up from the starter shingle's exposed butt edge, making sure fastener goes ³/₄" (19 mm) into the deck or all the way through the deck. (see Figure 18-12). For each full Cedar Crest shingle, place fasteners 8⁵/₈" (219 mm) up from its exposed butt edge and 1" (25 mm) in from each side edge (see Figure 18-13).

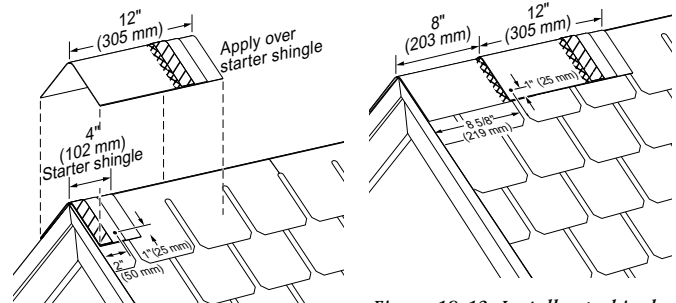

Figure 18-12: Apply a full cap shingle over the starter shingle.

Figure 18-13: Install cap shingles at an 8" (203 mm) exposure and fasten with one nail on each side as shown.

CEDAR CREST APPLICATION

Apply primary roofing up to hip or ridge on both sides of roof and trim flush. Ensure that the Cedar Crest shingles will adequately cover the top course of the shingles on both sides of the hip or ridge. Prepare a 4" (100 mm) "starter" shingle by cutting off the lower 8" (203 mm) color granule portion of one Cedar Crest shingle. Apply the 4" (100 mm) starter piece with raised overlay edge over the bottom corner of the hip or to either end of the ridge, overhanging the corner or end by approximately 1/2" (12 mm) and bending the starter shingle along its centerline to form into place (see Figure 18-12). Install a nail on each side about 2" (50 mm) up from the starter shingle's exposed butt edge and 1" (25 mm) in from each side edge of the shingle. Then apply a full 12" x 12" (305 mm x 305 mm) piece over the starter, bending the shingle along its centerline and forming it into place over the hip or ridge, flush with the bottom and side edges of the starter shingle. Fasten with two nails minimum 1³/₄" (45 mm) long with one nail on each side of shingle 8⁵/₈" (219 mm) up from the butt edge and 1" (25 mm) in from each side edge (see Figure 18-13).

Continue application of Cedar Crest shingles up the hip or along the ridge, forming each shingle over the hip or ridge, and fasten as shown in Fastening. Expose Cedar Crest shingles 8" (203 mm), covering all fasteners. To assist in proper alignment, snap a chalk line parallel to the hip or ridge applying along the line where the side edges of the Cedar Crest shingles should be.

IMPORTANT: High Wind Instructions. In order to achieve the ASTM D3161 Class "F" Wind Resistance Classification each "hip and ridge" shingle must be both – (1) fastened with nails as shown and (2) hand-sealed with two 1/4" (6 mm) wide beads of either BASF "Sonolastic® NP1™ Adhesive" or Henkel "PL® Polyurethane Roof & Flashing Cement" applied from the middle of the shingle's raised overlay on the top piece and extending approximately 4" (100 mm) along the sides of the headlap along a line 3/4"-1" (9 mm - 25 mm) in from each side edge of the shingle's headlap as shown. Immediately align and apply the next overlying shingle, gently pressing tab sides into adhesive. Only one side of

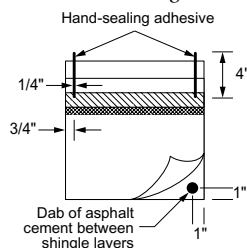

Figure 18-14: Hand seal caps the double thickness tab is laminated together; to secure the other side, after folding the shingle over the ridge and nailing into position, a 1" (25 mm) diameter spot of either NP1 or PL adhesive must be applied between the shingle layers as shown. Immediately align and apply the next overlying shingle, gently pressing tab sides into adhesive.

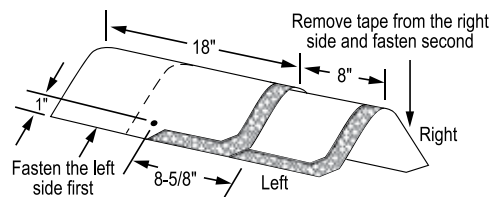

Figure 18-16: Installation of Shangle Ridge shingle on hips and ridges.

- If shingle-over ridge vents are being installed (see Figure 18-17), they must match the 12" (305 mm) width dimensions of the hip and ridge caps. Be sure to follow the ridge vent manufacturer's instructions. To attach the cap shingles to the shingle-over ridge vent, use hot-dipped galvanized nails of sufficient length to penetrate 3/4" (19 mm) into, or through, the deck.

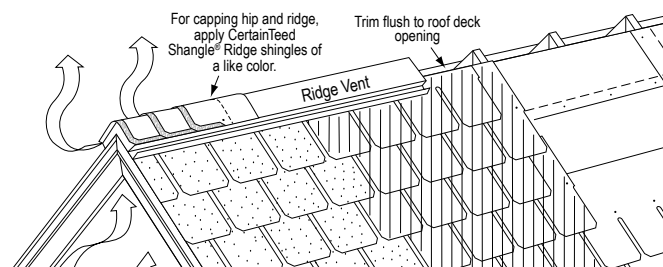

Figure 18-17: Installation of Shangle Ridge shingles on ridge vent.

SHANGLE RIDGE® HIP AND RIDGE

You can also use Shangle Ridge shingles to cover hips and ridges.

- Each shingle is a 12" x 18" (305 mm x 457 mm), color-coordinated, pre-assembled, double-layered product. Exposure is 8" (203 mm).
- Apply Belmont™ up to the hip or ridge from both sides and trim flush. Allow for adequate coverage by making sure the last course of shingles will not be exposed more than 8" (203 mm) when the cap shingles are applied.
- To assist with proper alignment when ridge vents aren't used, snap a chalk line parallel to the hip or ridge along the line where the side edges of the cap should be.
- If possible, try to start at the end of the ridge opposite to where the prevailing wind strikes the house. This will give the wind and rain less of a chance of getting underneath the cap. As for the hip, begin by installing the cap at the bottom and work your way up.
- Before nailing, be sure to remove the protective tape from the sealant between the cap's two layers (see Figure 18-15).
- Bend the cap along the centerline of its longer dimension so that it forms into place over the hip or ridge.
- Fasten each cap with two fasteners (see Figure 18-16). The fasteners must be 1 3/4" (45 mm) long, or longer, so they penetrate either 3/4" (19 mm) into the deck or completely through the deck, exposing at least 1/8" (3.2 mm) of the tip of the nail. Expose 8" (203 mm) of the accessory along the ridge or hip line and cover all fasteners.

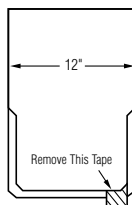

Figure 18-15: Shangle Ridge

REROOFING

"TEAR OFF"

It is important to determine that the roof deck is in satisfactory condition and the load-bearing capacity is adequate for application of these shingles. If the old roof consists of two or more layers of shingles, or if the roof consists of wood shingles (other than sawn square butt style), it is **required** to tear off (remove) existing roofing. If the old shingles have exposure lengths other than 8" (203 mm), it is **strongly recommended** to tear off existing roofing, since roofing over these shingles can lead to periodic patterns which may have an objectionable appearance. After tear-off, repair decking and/or install new decking, and apply underlayment, eaves flashing and shingles according to procedure in "4 1/2" (115 mm) Single-Column Vertical Racking Method" section.

"ROOF-OVER"

OVER ASPHALT SHINGLES (IMPORTANT): If Belmont shingles are applied over existing asphalt roofing shingles having exposure lengths other than 8" (203 mm), special application instructions must be followed in order to avoid raised shingle edges which can result in objectionable appearance and reduced performance of the roofing. Contact CertainTeed RPG Technical Service at 800-345-1145 for a copy of Belmont "Roof-Over" instructions.

OVER SQUARE-BUTT WOOD SHINGLES: If the roof consists of square-butt sawn wood shingles, apply beveled wood strips to obtain an even base and apply underlayment, eaves flashing and shingles according to procedure in "4 1/2" (115 mm) Single Column Vertical Racking Method" section.